

APP USER MAN- UAL



READ
BEFORE
YOUR
FIRST
RIDE

ENGLISH

Contents

1 PAIRING THE BIKE	1	charging on the bike	18
Pairing your bike	1	Bike controller and the Greyp App	19
Unpairing your bike	4	Automatic ride session recording	20
2 CONNECTIVITY AND MOBILE		Background services	21
DATA USAGE	5	Dashboard section	21
Bike's eSIM connectivity	5	Assistance level	22
Wi-Fi connection	5	Ride session	22
3 GREYP APP MODES –		Navigation	23
REMOTE AND RIDE MODE	6	Camera	24
Remote mode	8	Retro video	26
Remote control	8	Retro video gallery	28
Bike's current location		Fitness	31
and telemetry data	8	Terrain based range	33
Text to bike	9	8 ACCOUNT & PRIVACY	34
Aquire photo	9	Creating a Greyp account	34
Lock the bike	10	Creating an account with Google/ Facebook/Apple ID	34
Turn off bike	10	Log in /log out	34
4 NOTIFICATIONS		Reseting your password	35
Overlay notifications from the bike	11	Privacy	35
Notification center	12	Profile settings	36
5 ACTIVITY	13	Multiple accounts	36
Overall statistic	13	9 SOFTWARE UPDATE	37
Ride Session	14	Manual software update	37
Gallery	15	Manual software update tutorial	39
6 SETTINGS	16	OTA software update tutorial	41
Personal settings	16	10 CONTACT AND FEEDBACK	44
Bike settings	16	Bug reporting	44
7 DASHBOARD MODE	18	How to report a bug via Instabug	44
Phone holder and USB		Greyp support	45

1

Pairing the bike

Pairing your bike

Before commencing the pairing process, make sure that:

1. Your bike is turned on and in Wi-Fi range | 2. The Wi-Fi on your phone is turned on.



Tap **START PAIRING** and follow the steps in the Greyp App. Make sure to Allow the Greyp App access to your device's location so that it can scan for bikes in your vicinity. If you are denied access to your location, the Greyp App will ask you to go to Phone Settings and allow access manually.

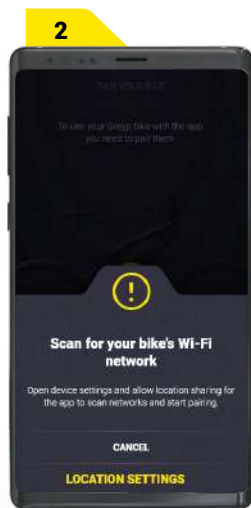
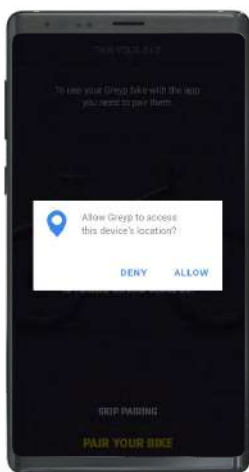

The App will scan for bikes in Wi-Fi range. Find your bike and tap on it. If you are unsure, check the VIN number on the frame or on the invoice and compare with the found bike.

If your bike was not found, please make sure it's is turned on and within Wi-Fi range. If you have an older bike model, it will require a manual software update before pairing.

Find out how to **Manually update your bike** below

When you tap and select your bike, the Greyp App will connect to it and pair with it. If the pairing fails, follow the instructions on the screen. If the problem persists, contact our customerservice@greyp.com

NOTE

A bike can be paired to only one account at a time.



Your phone must be connected to the internet.

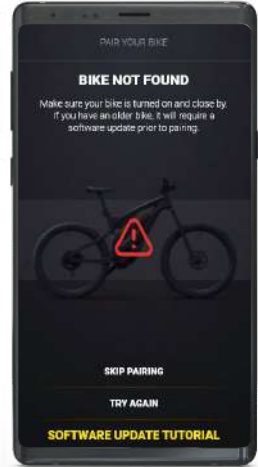

Follow these steps to pair your bike:

Scan the QR code from the bike's display. To access the Pair a bike screen with a QR code long press (3") Fn & then short press the Joystick on the bike controller. You should see the Info screen.

Navigate right to the Pair a bike screen and the QR code should be visible. When your bike's QR code is scanned, the Greyp App will connect to the bike and pair with it.

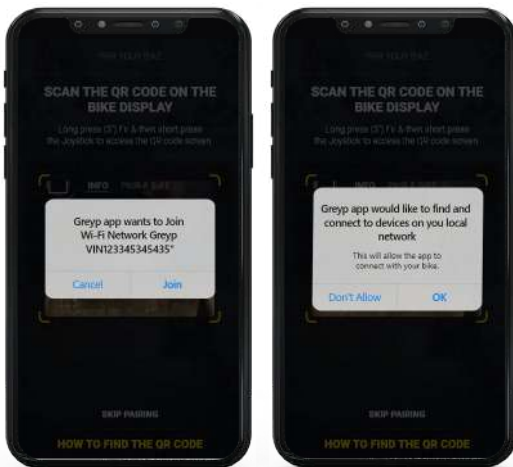
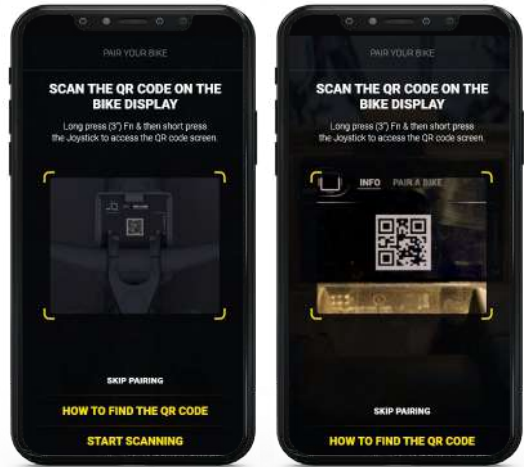

Make sure you allow the App to connect to the bike. If the pairing fails, follow the instructions on the screen. If the problem persists, contact our customerservice@greyp.com

NOTE

A bike can be paired to only one account at a time.

Your phone must be connected to the internet.



If you can't find the QR code screen, tap **HOW TO FIND QR CODE** and follow the on-screen tutorial. In case the Pair a bike feature is not available in the Info menu on your bike, you will need to update the bikes' software.

Find out how to **Manually update your bike** below



Unpairing your bike

To unpair your bike, go to Settings > Bike setting and tap Unpair bike.

After confirmation, your bike will no longer be paired.

The bike settings will be stored and activated if you choose to pair the same bike again.

2

Connectivity and mobile data usage

Bike's eSIM connectivity

The Greyp bike has a 3G module and an eSIM is permanently connected to the Internet in over 100 countries. While you are in Remote mode, and your bike is on, you can always track and control your bike.

Wi-Fi connection

Your bike is always connected, but the data is limited. When in Dashboard mode or when you are updating your bike's software, the phone and bike will connect to a joint Wi-Fi. Be aware that in this instance you are using the mobile data from your phone. To see the Wi-Fi connection status, check the Wi-Fi icon  in the status bar

When the Greyp App is running in the background for more than 10 sec, the Wi-Fi connection with the bike will be terminated.



When the Greyp App is running only in the background, the Wi-Fi connection with the bike will be lost immediately.

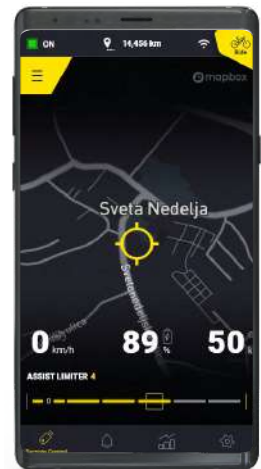

3

Greyp App modes – Remote and Ride mode

To switch between Dashboard and Remote modes just tap the button in the top right corner. When in Ride mode, your phone and bike must connect with Wi-Fi. Depending on the operating system, the Greyp App may ask you to join the bike's network. Please wait for a few moments, and if the connection is successful the App will switch to Dashboard mode.

Make sure that:

1. Your bike is turned on | 2. Your bike is close by | 3. Your phone has Wi-Fi enabled

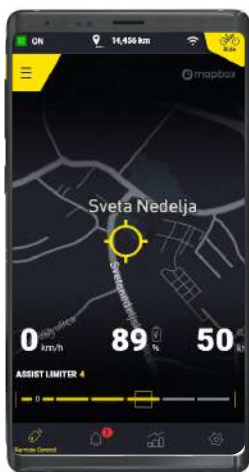



In case your bike is turned on and close by, but the Greyp App still can't switch to the Ride mode, go to the phone's Settings > Privacy > Local network and turn On the permission for the Greyp App.



Remote mode

Remote control

Bike's current location and telemetry data.

Greyp bikes are always online and you can stay connected even if you are apart. On the map, you will be able to see your bike's current location, speed, battery charge, and remaining range. In the status bar at the top of the screen, you can find how far are you from the bike and your current bike status.

The assistance level can be set remotely, and it won't be possible to change it above a limited level with the bike's controller. In case you forgot to turn the limit off, you will have to stop riding, go to the Remote mode, and set the limit to the maximum.

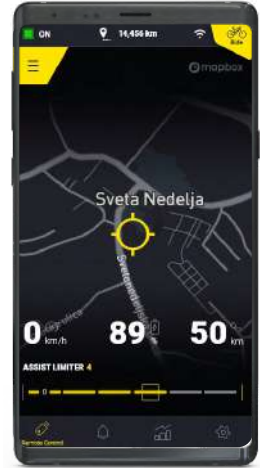

In case your bike lost connection, or it is turned off, the Greyp App will show the last known data. The App will indicate that bike is unavailable, and in the status bar, you can check your bike state.

Text to bike

Send a message of a maximum of 100 characters to the bike. The message will be presented on the bike screen. The bike rider will be able to see and dismiss your message, but won't be able to answer you directly from the Greyp App.



Acquire photo

In case you want to check out your bike, just choose the bike's front or rear camera and take the picture. Taken photos are not saved for now, but we are working on it.

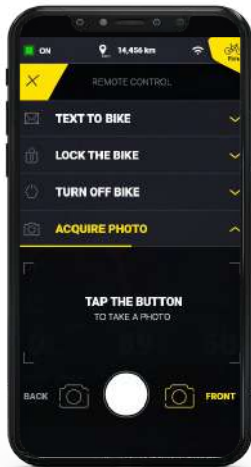

Photos you take from the front or back camera will be saved on your phone. You can preview them in the Greyp app gallery under the Photos tab or on your phone in the Photos app.

Lock the bike

Locking the bike is a part of Greyp's antitheft solution. The bike will display a message that it's locked and to return it to the owner. **By locking the bike, you will turn off its motor. It will keep recording all generated telemetry and displaying its latest location. It will also be able to notify you when somebody is touching or moving the bike.**

You can unlock the bike remotely from the Greyp App.



locking the bike

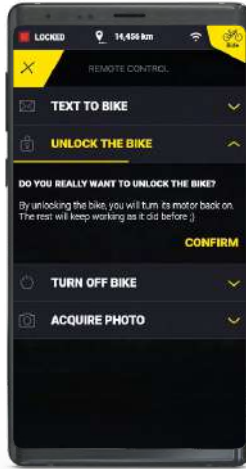

unlocking

Turning off the bike

When in standby mode, the battery charge level will get lower with time. Your bike can alert you when your battery level drops under a certain level (see **Notifications** for more) and you can turn it off completely if necessary.

NOTE

A bike can be paired to only one account at a time.

Your phone must be connected to the internet.

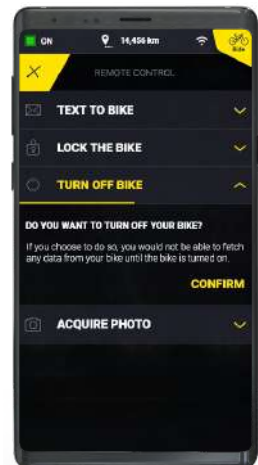

4

Notifications

Overlay notifications from the bike

In case something important is going on with your bike, you will get a notification whether you are in the Greyp App or not.

You can **customize notifications** you want to receive in the **Settings > Bike setting > Notify me**.



Notifications

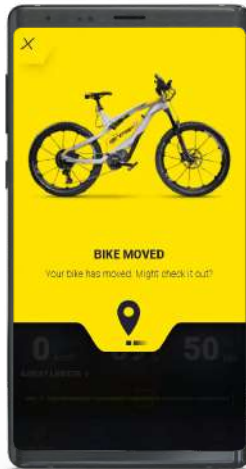

Notifications

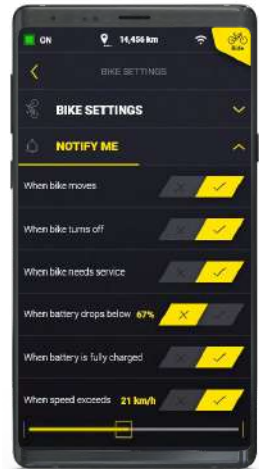

Customize Notifications

Notification center

All but the most important notifications will be dismissed automatically when you exit the Greyp App. You can also dismiss notifications by tapping **DISMISS ALL**.

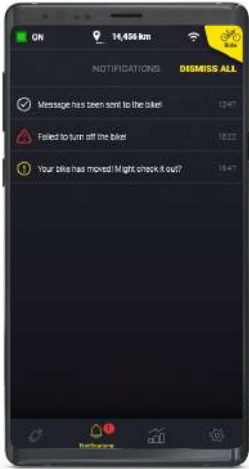

Types of notifications in the Greyp Application or on the bike:



Info messages: White color



Warning messages: Yellow color



Alert messages: Red color

5

Activity



Activity has not yet been implemented in the iOS version of the Greyp App but we are working hard to make it happen. Recorded pictures and videos can be found in the Gallery, accessible from the bottom menu.

Overall statistics

Your bike automatically records all your rides. In the Activity section of the App, you'll find the overall distance travelled, time spent on the bike, and the number of rides taken from the time you got your bike.



Activity



All Stats

If you want to know more, go inside **ALL STATS** and find out all the data gathered from your rides.

Last Ride Session

Besides checking and ending ongoing ride sessions by tapping **FINISH RIDE SESSION**, the Activity screen shows all the recorded Ride sessions from the past as well as the Video gallery.

Tap **ALL RIDE SESSIONS** to find the list of all your rides. Tap on any ride session to find details from that ride. In the **DETAILS** tab, along with the GPS route, you'll find a list of additional telemetry data from the ride, while under the **TIMELINE** tab you can find details on specific moments from the ride.



All Ride Sessions



Details



Timeline

Gallery

All videos recorded during a ride will be saved on your phone and you can preview them within the Greyp App. Choose between a List or a Grid view. Select and delete videos by long-pressing the video thumbnail.



Video Gallery

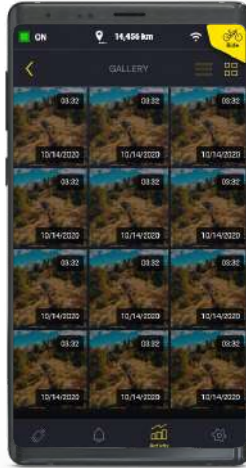

Grid View



Selecting/Deleting



Together with the videos recorded by your bike, in the Gallery, you'll also find pictures taken remotely by the Greyp App. Choose between a List or a Grid view or select/delete videos by pressing SELECT and choosing the videos you want to delete.

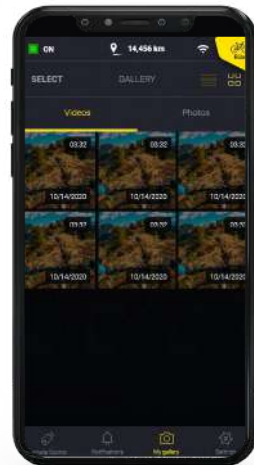

6

Settings

Personal settings

Find out more about your account settings in the [Account&Privacy](#) section of the user manual.

Bike settings

While riding a bike you can turn the lights On or Off at any moment using a bike controller, but from the Bike Settings, you can choose if the light will turn on by default.

Change the motor's Torque sensitivity to get a different response from the bike's motor when commencing your pedalling. Lower the Torque sensitivity level to get a smoother start or make it higher to get more aggressive acceleration when starting a ride.

You can also change all (bike and notification) settings to their default values by tapping **RESET BIKE SETTINGS**.

Tap **UNPAIR BIKE** to remove the bike from your account. After you confirm you want to unpair your bike, your bike will no longer be shown in the app. Bike settings will be stored and activated if you choose to pair the same bike again.

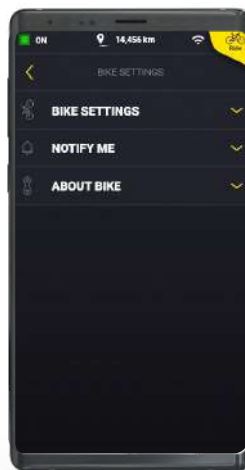

Reset Settings



Unpair Bike

Customize which notifications you want to receive from the bike from the **NOTIFY ME** tab in the drop-down menu.

Find out more about notification details in the **Notifications** section of this user manual.

Tap **ABOUT THE BIKE** to get all the important information about your bike, motor, and battery software.

7

Dashboard mode

To switch to Dashboard mode just tap the button in the top right corner. When in Dashboard mode, your phone and bike must connect through Wi-Fi. Depending on the operating system, the Greyp App may ask you to join the bike's network.

If the connection is successful, the Greyp App will switch to Dashboard mode. Make sure that your bike is turned on and your phone has Wi-Fi enabled.

Phone holder and USB charging on the bike

Before starting a ride, make sure your phone is securely placed on the bike. Pull the rubber hook upwards, place your phone underneath and center it horizontally. It should sit firmly in place while you are riding the bike.

Since using a phone while riding can be battery-consuming, you also got a cable with your bike to charge your phone while riding. Follow the instructions in the picture below and make sure you are not riding on crazy rough terrain while charging your phone.

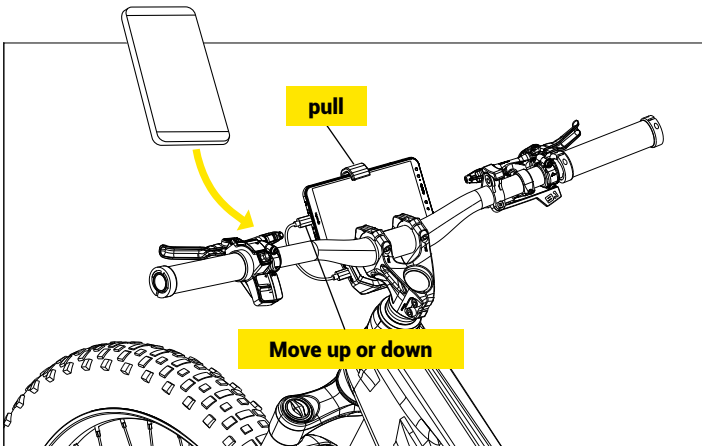

Bike controller and the Greyp App

The bike controller unit is designed to fit the needs of a modern e-bike rider. You can use it to turn the bike on/off, change assistance levels, control the bike's display, and a lot more. To learn more about how the bike controller works with the bike, check the printed User manual you got with your bike or download it from Greyp.com.

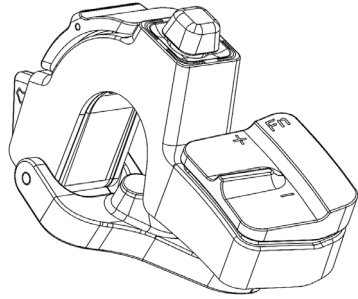

The bike controller is also used to control the Greyp App in Dashboard mode. Some actions, like typing the address in the navigation will be done by tapping the phone screen, but while riding you are able to control the Greyp App only by using the Bike Controller (CBC) on the handlebars.

The following tutorial gives you advice on how the bike controller helps you control the App remotely by using the handlebar controls.

To **go through the Dashboard sections**, press left or right on the joystick 



Inside a section, press up/down to get additional info. 

You can **switch between front and back cameras**, change satellite to terrain view in the **Navigation screen** or **Terrain Based Range screen**, or use it to scroll through additional data in the **Ride Session** screen.



By pressing  or long-pressing  on the joystick you will start, pause or stop recording the action displayed in the screens.

In the Camera Mode, pressing the joystick will start or stop the recording. Navigation will also start (after you input the destination address) when you press the joystick.

Start or pause the Fitness Mode by pressing the joystick and end it with a long press of the same button. In the Ride Session screen, reset the ride sessions with a long press of the same button.

Automatic ride session recording

The bike will automatically start and record the ride session when you start riding your bike.

If you stop moving for more than 3 sec, or you place the bike in standby mode, or you begin pushing your bike without turning the pedals, the ride session will be paused. When you start riding again, the ride session will automatically continue.

To finish the ride session:

1. Turn off or reboot the bike
 2. Long press the bike controller in the Ride session screen
(current ride session will stop, and a new ride session will start)
 3. Go to Remote mode > Activity, find Ongoing ride session, and tap FINISH RIDE SESSION.
-



Since the Activity section is not available yet, to finish the ride session you can:

1. Turn off or reboot the bike
 2. Long press the bike controller in the Ride session screen (your current ride session will stop, and a new ride session will start)
-

Background services

If you start Turn-by-turn navigation or a Fitness session, it will remain active even if you switch to another screen in the Application, including using it in the Remote mode. To end the navigation or the fitness session you will need to go back to the specific section in Dashboard mode and press the joystick.

If you choose to do so while recording a video, your recording will end, and the video will be saved.



Both Turn-by-turn navigation and Camera recording will continue if you switch to another screen in the Greyp App, even in Remote mode. To end turn-by-turn navigation or your recording you will need to go back to the specific section in the Dashboard mode and press the joystick accordingly.

Dashboard section

The dashboard section on the right side of the screen remains the same in all screens in **Dashboard mode**. It contains the following:

- Current speed
- Time
- Bike's battery level (When the battery level is below 30%, the battery bar will turn red)
- Range depending on the current assistance level
- Bike status



Assistance level

The Greyp bike has five levels of assistance. Yellow bars indicate the current assistance level. If the assistance level was limited from within Remote mode, the number of the assistance bars available will change. To change the assistance limit level, go to the Remote control screen in Remote mode.





Ride session

The Ride session screen contains all the telemetry data from your current ride session. Press the joystick up or down to switch between different sets of information.



Long press the joystick to reset the ride session and you will get to the confirmation screen.

To cancel, press left on the joystick  and press the center of the joystick to confirm. 

The previous ride session will be saved in Activity and a new one will begin.



Not yet available in the iOS version of the Greyp App.

Navigation

Add destination location and follow bike-specific turn-by-turn navigation.

To add a destination press the search icon in the top left corner and start typing an address or just tap on the map.



When you choose the destination, your route will be presented. You can Zoom in/out of the map by pinching the screen or change the view to its default state by tapping the re-center button. 

Start turn-by-turn navigation by pressing the joystick.



In the top left corner, you can check how far the next turn is and how far you are from your destination. To switch between satellite and terrain modes press up/down on the joystick.

The navigation will end when you reach your destination, or you can end it manually by pressing the joystick.

NOTE

 If you can't see your current location please make sure you allow the Greyp App to access your location from the phone's settings.



In case you didn't allow the Greyp App to access your location you will have to go to **Settings > Privacy > Location services** and enable location access to the Greyp App.



Camera

Most Greyp bikes have two wide-angled 1080@30fps cameras. One camera is positioned on the cockpit beneath the dashboard and the second rearward facing camera is beneath the saddle or on the rack.

Switch between cameras by pressing up/down on the joystick. Start or end the recording by pressing the joystick. All the videos will be stored on your mobile device. You can also preview or delete videos in the Remote mode > Gallery.



Before recording, in the top left corner, depending on the space available on your mobile device you will be informed how long the recording can be, until the memory on your phone is full. If your phone's memory is already full, the Greyp App will inform you and recording will be disabled.

You can switch cameras while recording and everything will be recorded as one video. In case your phone's memory becomes full, the recording will end but the video will be saved up to that point.



NOTE



To record videos, you must allow the Greyp App to access media and other files on your phone.



If you are an iOS user, you won't have to give any permission to record and save videos on your phone



NOTE



Do not use the rear camera view as a rear mirror because the picture is flipped and there is a small lag.

NOTE

In case the video stream from the cameras is not available and you get a Camera error icon, the camera has been unplugged or there was a malfunction.



Please check if the cameras are plugged in, and contact Greyp support if necessary.



Retro Video

Record the last 30 seconds (front camera) of the ride on your bike by pressing the Retro video button on the bike controller . Find out more about the Retro video button in the [General bike manual](#).

A Retro Video can be saved from any screen in the Ride mode and even without the Greyp app running.



Retro videos will be saved to the bike's memory. Download or delete Retro videos from the Gallery in Remote mode. Find out more about downloading or deleting Retro videos in the [Retro video Gallery section](#) of this user manual.

Up to 9 Retro videos can be saved to the bike. If your Retro video memory on the bike is full and you record a new Retro video, new Retro video will be saved but the oldest recorded Retro video will be replaced.



You can see the number of saved Retro videos in the top right corner of the Camera section. In case your Retro video memory is full, the icon will indicate it, by turning red



For a Retro video to be saved, the bike has to be On for at least 30 seconds.



If the bike was in Stand by mode, and a Retro video is saved within the first 30 seconds of the bike being turned on, the saved Retro video will contain the last available 30 seconds. This means the video will contain not only the recording from the moment it was turned on, but also, the recording prior to the bike going into Stand by mode.

For Retro videos to be successfully saved, your bike has to be updated to the latest software version. Fortunately, a software update is not as complicated as it used to be, so you can do it quickly through the Remote mode. Find out more about our Over-The-Air updates in the [OTA software update section](#) of this user manual.

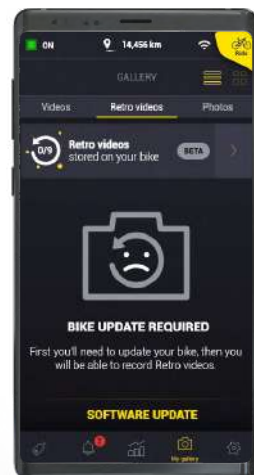

Retro video gallery

Swipe to switch between Video, Retro video and Photo tabs.

In the Retro video section of the Gallery, you can download or delete Retro videos saved to the bike. Tap the Retro video card at the top of the screen.

To fetch Retro videos from the bike, connect with it over Wi-Fi . (Make sure your bike is turned on and close by. The Wi-Fi on your phone must be on.)

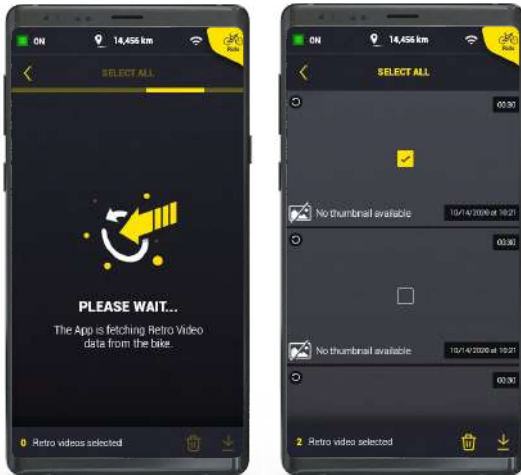
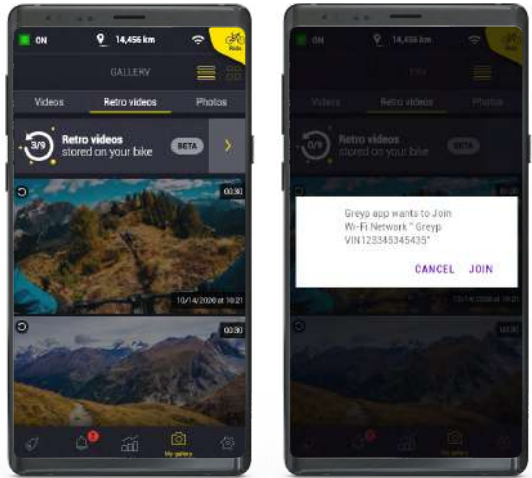

You'll see a list of Retro videos saved to the bike, along with the duration and time of each. For now thumbnails are not available, but we are working hard to add them in the next update.

Make your selection by tapping the videos and download them from the bike to your phone memory.

All downloaded Retro videos will be deleted from the bike and listed in the Retro video section of the Gallery.



In case Retro video card says: "The bike is unavailable, number of Retro videos is unknown", it means your bike or the phone do not have internet connection.

Up to 9 Retro videos can be saved to the bike. In case the Retro video memory on the bike is full, you will get a notification when you open the Grey App in Remote mode. To clear the Retro video memory on the bike, go to the Gallery and download or delete Retro videos from your bike.



Downloading Retro videos can take a few minutes and you can see the progress from the Gallery. Use the rest of the app freely, while the Retro videos are being downloaded. A few Features will be disabled though: Ride Mode, Remote Turn off, Loggin Out, Unpairing the bike, as well as performing a Bike Software Update. When the Retro videos finish downloading, you will get a notification.

Please do not exit nor close the app during the download.

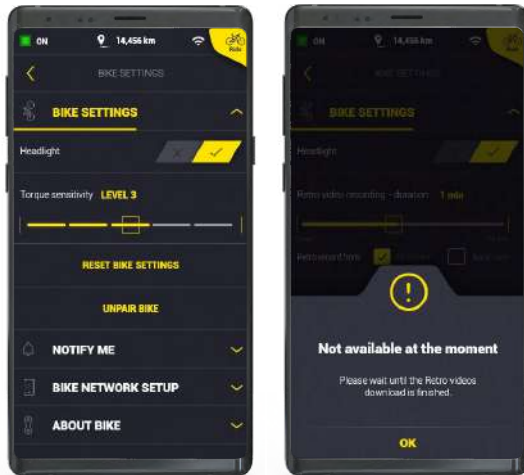

If an error occurred while downloading multiple videos, or you chose to cancel the download - only the completely downloaded Retro videos will be deleted from the bike and visible in the Gallery.

Fitness

As part of its standard equipment, a Greyp bikes come with a heart rate monitor. Connecting the heart rate monitor is simple, you just need to turn the bike on, turn on the heart rate monitor, and wait until the green light appears. The heart monitor will connect automatically, and the Fitness Session screen will become available.



Modify the heart rate zone using the two yellow dots on the screen - just tap on each dot and drag up/down to adjust maximum and minimum heart rate. When you are ready to start training, press the joystick on the bike's controller.

The bike will automatically adjust the assistance level to keep you in the desired heart rate zone. In case this is not possible, you will get a display notification.



While training, you can follow your most important fitness data such as: calories burned, current heart rate, cadence, and time/distance travelled. You can **adjust your heart rate zone** by tapping the **EDIT TRAINING ZONE** bar, at any moment.

Press the joystick to pause the Fitness Session, or long-press it to end the Fitness Session.

NOTE

If you pause the Fitness Session, we'll keep the current Ride session's data. Also, Fitness Sessions are not saved in the Activity section.

TIP

To take full advantage of the Fitness Session, plan ahead a bit. It is hard for a bike to keep your heart rate up if the terrain is going downhill or to keep your heart rate low enough if the terrain is extremely steep.



Not yet available in the iOS version of the Greyp App.

Terrain based range

This feature allows the calculation of the range for the user depending on the surrounding topographical data and the current assistance level. It shows you how far you can ride with the battery state of charge and at the current assistance level.

Tap anywhere on the screen around your current location and you will be displayed a yellow line showing how far you can go in any direction in the current assistance level. Change assistance level and the line will adjust.



At the bottom of the screen you will find the terrain vertical profile, highest altitude, and distance for the selected route:

Yellow – you can reach the destination and come back



Grey – you can reach the destination, but it is not possible to come back



Red – the destination is out of your range

NOTE



It is impossible to calculate terrain-based range if your assistance is turned off, so the Greyp App will keep showing you the last calculated range.



Not yet available in the iOS version of the Greyp App.

8

Account & privacy

Creating a Greyp account

To use the Greyp App, you need to create an account. Name, email and password are required, and the rest of the data is optional. By tapping SIGN UP, your account will be created, and you can proceed with pairing your bike.



Creating an account with Google/Facebook/Apple ID

If you've never had a Greyp account before and would like to use the Google/Facebook/Apple ID login, simply select one of the options and follow the steps. This will create a new Greyp account. Name, last name, and email will be added to your profile, and the rest of the personal information can be added through **Settings > Personal settings**.

Log in /log out

If you're struggling to log into your account, the most common reason is a mistake in your email address or password. Please double-check for typos or spelling errors and try again.

If you created your account using the Google/Facebook/Greyp Apple ID login option, please continue to use this to log in. It is not possible to log in to the same account with an independent password and email if your account was created with Google/Facebook/Greyp Apple ID.

To log out, go to **Settings > Personal settings** and tap **LOG OUT**. After confirmation, you will be returned to the log-in screen.

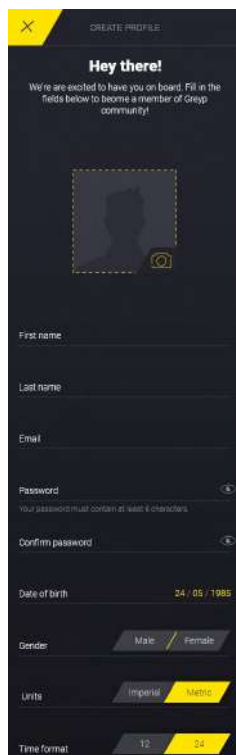

Resetting your password

If you've forgotten your password, you can reset it by tapping **FORGOT YOUR PASSWORD**. Enter your email address and you will receive a reset link in your inbox. Follow the link and enter the new password manually, to ensure there are no copy/paste errors and that the password has more than 8 characters. Once the new password is entered, press **SAVE** and you will get a confirmation saying you can sign in with your new password.



Resetting Paswords



Entering New Password



Changed Password

Privacy

Your privacy is important to us, and we're committed to providing meaningful choices about how the personal information you choose to share with Greyp Bikes is used.

By Signing up or Logging in, you indicate that you have read and agreed to the Terms of Use & Privacy policy. You can read more by tapping on each link. You will be notified in case there is a change in the Terms of Use or the Privacy policy.

Profile settings

To view or edit your profile data in the Greyp App, go to **Settings > Personal settings**.

In your Profile settings, you can manage your personal info such as name, password, date of birth, gender, weight, resting heart rate, and set units or time format throughout the Greyp App.

Changing a password is possible only when an account wasn't created using the Google/Facebook/Apple ID login option. You will have to enter the old password, new password, and repeat the new password to make sure there are no spelling mistakes. Please make sure the new password is different from the old one, and that it has more than 8 characters. Once the password is changed, you can use it the next time you try to log in to the Greyp App.



Multiple accounts

Only one account at a time can be paired to a bike. In case you have multiple Greyp accounts, they will have different bike settings depending on your choices, specific activity, etc. Videos and pictures taken with the bike will be visible to all Greyp accounts using the same phone.

It's not possible to merge two Greyp accounts. If you've created multiple accounts and are trying to keep the content on both, we recommend you choose which account to keep based on the number of rides and delete the other one.



Only one account at a time can be paired to the bike. In case you have multiple Greyp accounts, they will have different bike settings depending on your choices, specific activity, saved videos, pictures, etc.

9

Software update

OTA Software update is a free service for all Greyp users who want to keep their bikes up-to-date. In case you have a bike with an older version of software you will have to update your bike manually, but you will need to go through this process only once. The following bike software update will be done in just a few taps.

Manual software update

If you are trying to pair a bike with an older software version, the Greyp App won't find your bike. Make sure your bike is turned on and within Wi-Fi range, and if the Greyp App still can't find your bike, it probably needs to be manually updated. In case you are already paired, since this is a critical update, your Dashboard mode will be disabled until you update your bike. Please follow the manual software update tutorial in the App.

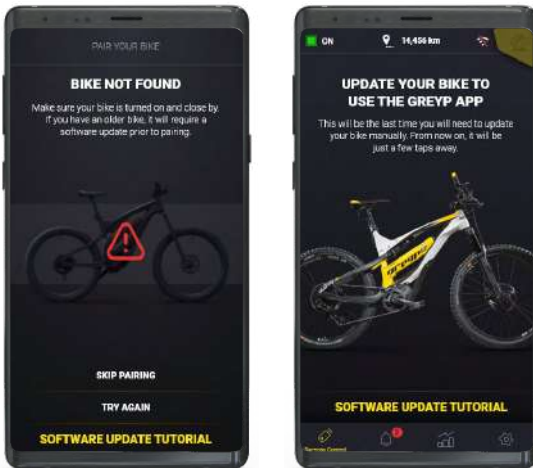



In case you are trying to pair the bike with an older version of software, the pairing will fail. Please follow the manual software update tutorial from the App.



Manual software update tutorial

Since your bike and your account are not connected in this moment, you will need to follow the App tutorial and have a little patience. **Thank you upfront!** Please check the bike and make sure you complete each step of the tutorial before proceeding to the next one.



The manual software update is the same as for Android users, with a difference in **Step 2**.

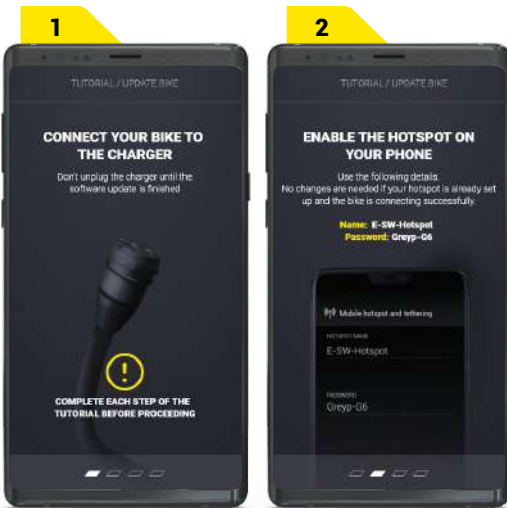

1. Connect the bike to the charger

2. Enable the hotspot on your phone.

Go to Settings > Mobile hotspot and tethering and change the phone's hotspot name to E-SW-Hotspot, and set the password to Greyp-G6 (case sensitive). If your hotspot is already set up and the bike is connecting successfully, you don't have to change hotspot credentials.



2. Change your phone's name in **Settings > General > About > Name**, and the *Wi-Fi password* in **Settings > Personal Hotspot**. If your hotspot is already set up and the bike is connecting successfully, you don't have to change the phone's name and Wi-Fi password.



3. On the bike controller, Long press the Fn button (3 sec) and then short press the Retro video button. When you release the buttons, the update should begin. In case you don't see a software update message on the bike display, please try again.



4. Wait for the software update to finish. You can follow the progress on the bike's display- When the software update has finished, restart your bike and unplug the charger. When you are done, you can close the tutorial using the yellow button and pair your bike.



5. In case the update failed, tap on the button at the bottom of the screen. You will have to check the bike display and follow instructions from the Greyp App.



OTA software update tutorial

In case there is a new software update for your bike available, you will get a notification on your phone. Follow the link from the notification to update the bike or close the notification and follow the badge on the Settings tab.

Tap **BIKE SOFTWARE UPDATE** and start the update process.

The software update is done through three steps:



Download the software update file

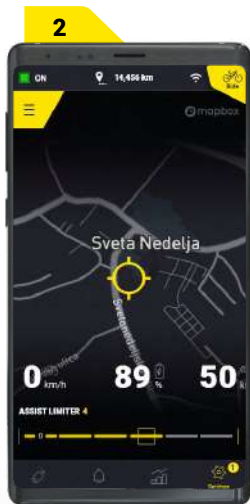

Upload the update to the bike

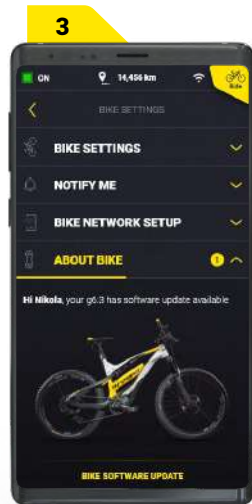

Install the update on the bike

STEP 1.

You can download the software update to your phone's memory without your bike, but you will need your bike in the vicinity when you want to upload and install the software update on it.

If you exit the software update process after downloading the software update file, you'll get a reminder to continue with the software update, the next time you open the Greyp App.

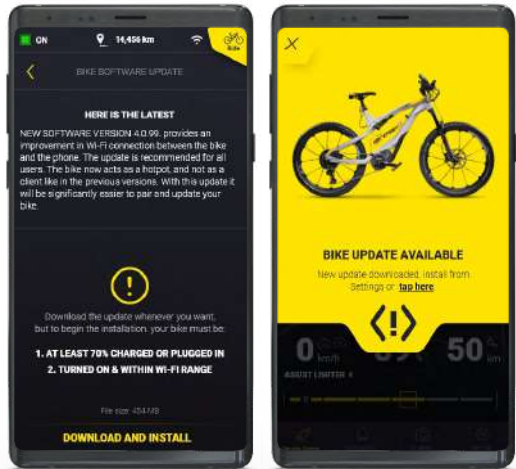

STEP 2.

Before proceeding with the software update, make sure:

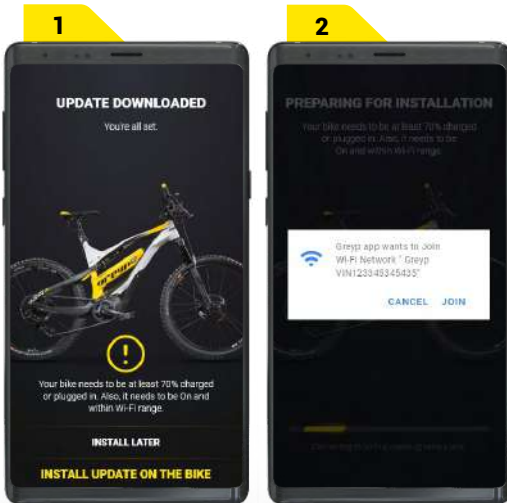

Your bike has at least 70% battery or is plugged in

Your bike is On and within Wi-Fi range

The Greyp App and the bike will connect through Wi-Fi. The App will check the bike's battery level and if everything is OK, the upload to the bike will start. Please make sure your bike stays within Wi-Fi range and you don't close nor exit the Greyp App until the update has finished.

STEP 3.

After the file is uploaded to the bike, installing the software on the bike will start automatically. When the software update has finished you will get a notification saying the bike will automatically reboot and the software update will be completed.



In case you choose to exit the Greyp App or if the Wi-Fi connection fails, the installation process will continue but you will have to check the bike display to make sure your bike is still being updated. If the update is successful, the bike will reboot, and you will get a notification that the Update is completed.

If the update failed you will need to repeat the last two steps of the software update process from the Greyp App.

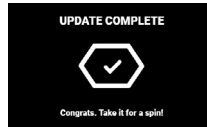
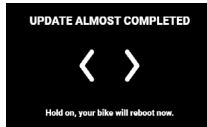
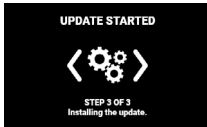

10

Contact and feedback

Bug reporting

If you notice something obviously broken, report it as a bug. The Greyp Application has an integration with Instabug which we at Greyp Bikes use for easy bug reporting. When you notice a functional problem in the Greyp App you can just use the standard screenshot button combination and it triggers the bug report. Also, there is a link in the Settings section ---> **GIVE US YOUR FEEDBACK.**

How to report a bug via Instabug

Please always report one issue per one Instabug report. Enter the details, add an additional screenshot or screen recording and send it. We are aware that sending a full written report on a mobile device is difficult, but it adds more value and helps speed up the resolution. We will get back to you on each report and can continue the conversation through email if you want to add more data later.

THE BUG REPORT STRUCTURE SHOULD CONTAIN THESE SECTIONS:

Description	sentence or two about the problem description
Pre-conditions	state of the user, Greyp App, and bike relevant for the problem. Numbered list
Steps	numbered list of steps taken to trigger/reproduce the bug
Actual behavior	what exactly happened
Expected behavior	what you expected to happen

Example of the bug report:

1. Navigation cannot end when a video recording session was active, and after the navigation feature started.

Pre-conditions:

1. User paired to bike.
2. User logged in to the Greyp App, mobile connected to bike over Wi-Fi.
3. Greyp App in Dashboard mode.

Steps:

1. Navigate to the Navigation section.
2. Found and started the route.
3. Navigated to the Camera section.
4. Started recording video.
5. Ended recording video.
6. Navigated back to the Navigation section.
7. Tried to END the navigation session, through CBC and with a tap on the screen.

Actual behavior:

Navigation cannot be ended.

Expected behavior:

Navigation should end to enable me to start a new one, without closing the Greyp App or going to Remote mode.

Greyp support

For any other issue or claim, contact: [**katarina.kemeter@greyp.com**](mailto:katarina.kemeter@greyp.com)

How to report an issue or claim:

Once you contact Greyp support via the provided email address, you will need to prepare some information upfront. Please always use the following details when describing the occurrence, as this will facilitate our customer support team's troubleshooting steps:

[**https://greyp.me/How_To_Manual**](https://greyp.me/How_To_Manual)

1. Provide us with the VIN (serial) number of the bike. The VIN can be found on
 - a) your invoice,
 - b) the frame below the motor, engraved,
 - c) in the Greyp App under Settings, About the bike, or
 - d) in the info screen
2. Which model you have (e.g. G6.2, size L)

3. *Your name and the name of the dealer/person you bought the bike from*
4. *Date of purchase*
5. *Battery serial number (e.g. BA1238756)*
6. *Current km/miles status*
7. *Current software version (visible in the Greyp App and/or the Info screen)*
8. *When did the issue occur (date and time) and under what conditions (during a ride, prior, after, weather conditions, type of terrain)*
9. *Description of the problem*
10. *Steps taken so far (if you tried to remedy the issue yourself)*
11. *Attached photos and/or videos of the issue(s)*

Since we are constantly working on improving our user experience, you can expect frequent mobile app updates

FIND THE LATEST VERSION OF THE GREYP APP MANUAL ON OUR WEBSITE

WWW.GREYP.COM



The Greyp mobile application
is available on
[**Google PlayStore**](#) and [**AppStore**](#)

Greyp Bikes d.o.o.

Ljubljanska 7

10431 Sveta Nedelja

Croatia

Tel: +385 1 409 3377

Fax: +385 1 333 6698

info@greyp.com

GREYP 